

**Lightrax quick drop**

**Over the top (FRH-QD1-O-YL)**

**100 mm duct**

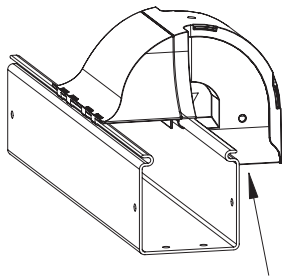

Apply the self adhesive tape

**200 + 300 mm duct**

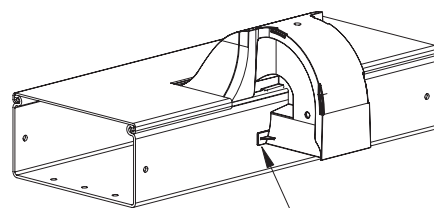
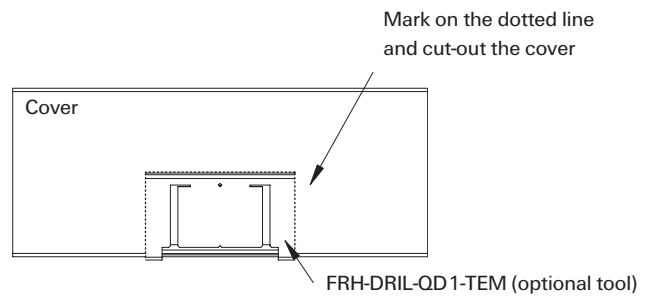

Apply the self adhesive tape

In case of 200 or 300 mm PVC duct (bigger wall thickness) keep the quick drop under an angle to mount

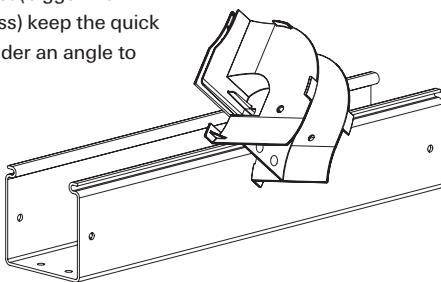

## In the duct (FRH-QD1-I-YL)

Starting from  
FRH-QD1-O-YL

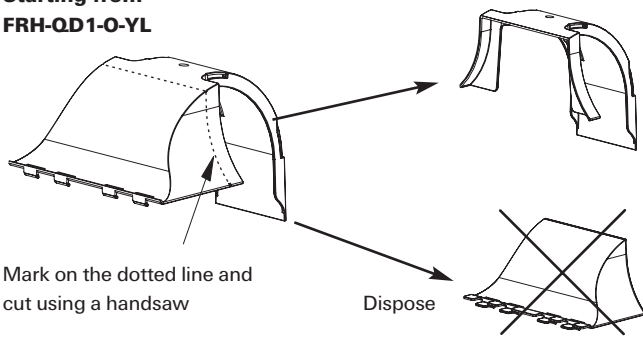

Mark on the dotted line and cut using a handsaw

Dispose

FRH-QD1-I-YL

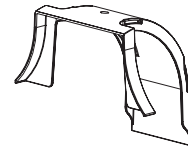

### Optional tool

Quick drop installation template  
(FRH-DRIL-QD1-TEM)

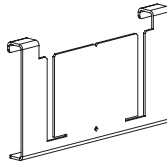

Use the quick drop installation template (FRH-DRIL-QD1-TEM) to mark the duct

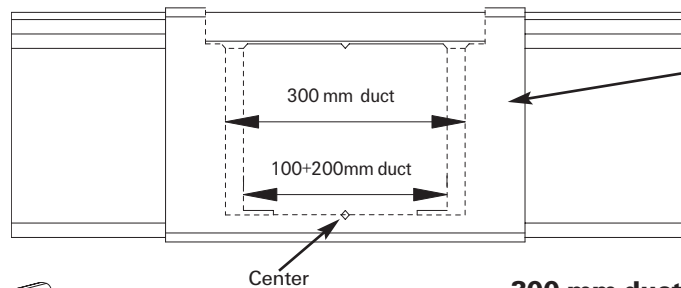

FRH-DRIL-QD1-TEM

100 + 200 mm duct

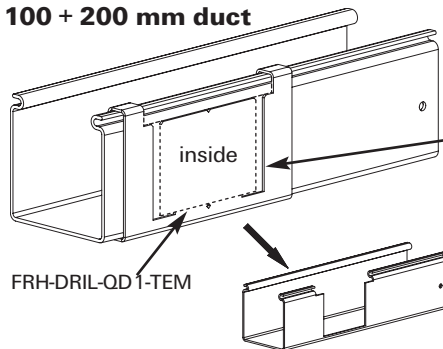

FRH-DRIL-QD1-TEM

Mark on the dotted line and cut using a saw

300 mm duct

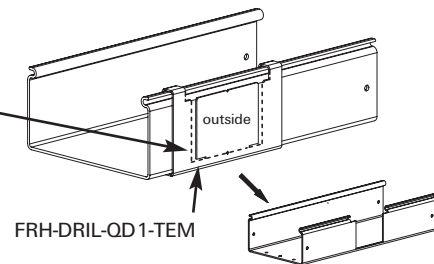

FRH-DRIL-QD1-TEM

## Adapters to flextube

Can be used for "In the duct" and "Over the top" applications. More options are possible; see ordering guide.

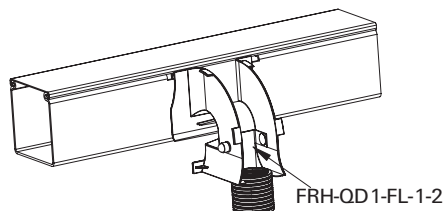

FRH-QD1-FL-1-2

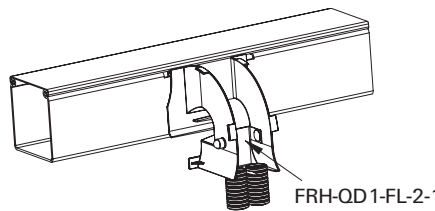

FRH-QD1-FL-2-1

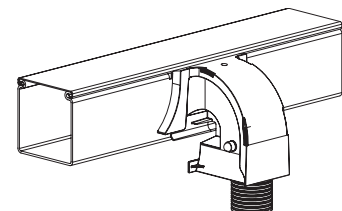

## Tyco Electronics Raychem NV

Diestsesteenweg 692  
B-3010 Kessel-Lo, Belgium  
Tel.: 32-16-351 011  
Fax: 32-16-351 697  
www.tycoelectronics.com  
www.telecomosp.com

Tyco Electronics, TE logo and Lightrax are trademarks

The information given herein, including drawings, illustrations and schematics which are intended for illustration purposes only, is believed to be reliable. However, Tyco Electronics makes no warranties as to its accuracy or completeness and disclaims any liability in connection with its use. Tyco Electronics' obligations shall only be as set forth in Tyco Electronics' Standard Terms and Conditions of Sale for this product and in no case will Tyco Electronics be liable for any incidental, indirect or consequential damages arising out of the sale, resale, use or misuse of the product. Users of Tyco Electronics products should make their own evaluation to determine the suitability of each such product for the specific application.